

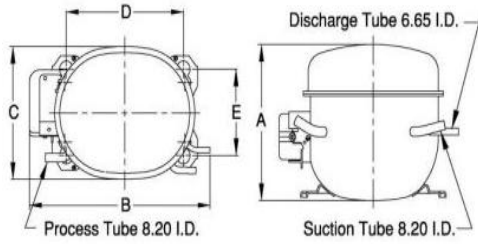

PRINCIPAL DIMENSIONS - mm



A: 204	B: 265	C: 155	D: 165	E: 102
--------	--------	--------	--------	--------

SCHEMATIC WIRING DIAGRAM C.S.R.

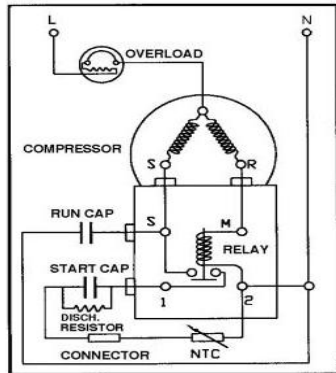

SCHEMATIC WIRING DIAGRAM -

MOUNTING KIT

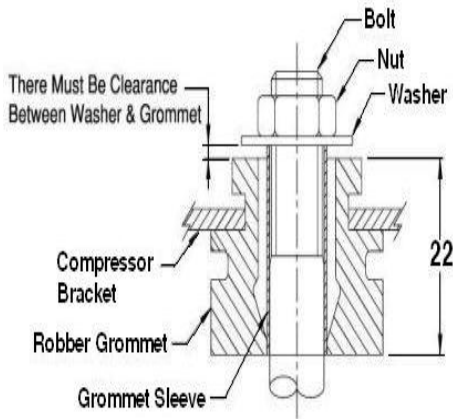

Electrical : 220-240 V/50 Hz. 1 Phase

Nominal Performance

Capacity	307 / - Watts
	1,047 / - BTU/Hr
	264 / - Kcal/Hr
Power Input	285 / - Watts
Locked Rotor Amps	12.00 / - Amps
Max Continuous Current	- / - Amps
Rated Load Amps	1.50 / - Amps
COP	1.08 / - Watts / Watts
EER	3.68 / - BTU/W-Hr

Testing Conditions

Condensing Temperature	54.40 °C	129.9 °F
Evaporating Temperature	-23.30 / - °C	-9.9 / - °F
Liquid Temperature	32.20 °C	90.0 °F
Return Gas Temperature	32.20 °C	90.0 °F
Ambient Temperature	32.20 °C	90.0 °F

Application

Evaporating Temp. Range	LBP	@ -30.00 ° C to -12.20 ° C (-22.0° F to 10.0° F)
	Heat Pump	- ° C to - ° C (-° F to -° F)
Refrigerant	R22	
Refrigerant Flow Control	Capillary Tube	
Compressor Cooling	Fan	

Compressor and Motor data

Compressor Type	Reciprocating
Displacement	8.86 cc.
Oil Type	Mineral Oil
Oil Charge	364 cc.
Motor Type	C.S.R. ; 2 Pole 2,850 / - r/m
Voltage Range	187 - 264/- Volts 50/- Hz.
Winding Resistance at 25 ° C	
Start	17.70 Ohms
Run	6.10 Ohms
Weight with Oil	10.26 Kg.
Weight with Oil and Accessories	10.91 Kg.

Electrical Components

Motor Protector	
Type	External 3/4"
Model Number	KME660-6/C
Open / Close	90-100 / 70-52 ° C
1st Cycle trip at 25 ° C	7.40 Amps(main) - Amps(start)
Motor Starter	
Type	Current Relay
Model Number	KME682-1NT
Pick Up (max.)	6.70 Amps
Drop Out (min.)	5.90 Amps
Terminal Cover	KMD 901-12
Start Capacitor	36-43 µF 330 VAC.
Disch Resistor for Start Cap	15000 Ohms 2 W
Run Capacitor	8 µF 450 VAC.

Mounting Kit

Rubber Grommet	4007KMD905-3
Sleeve Grommet	3KMD903-2-Z
Washer	4023KEB387

Since we are constantly improving our product , the specification are subject to change without notice.

REV. DATE	C / N No.
23-03-16	0085/16

Certificate Marks

