

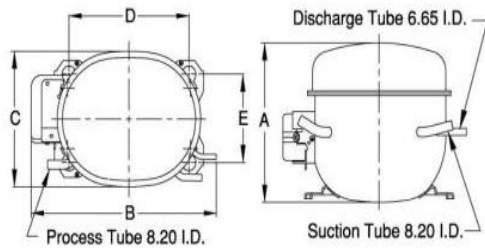

PRINCIPAL DIMENSIONS - mm



A: 204	B: 265	C: 155	D: 165	E: 102
--------	--------	--------	--------	--------

SCHEMATIC WIRING DIAGRAM C.S.R.

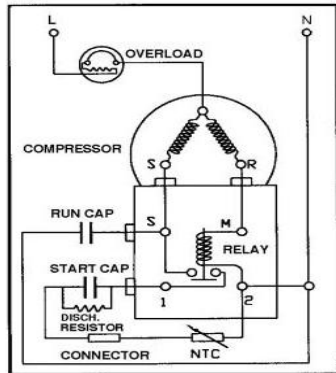

SCHEMATIC WIRING DIAGRAM -

MOUNTING KIT

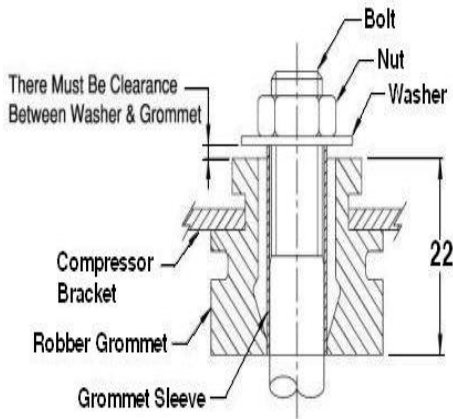

Electrical : 220-240 V/50 Hz. 1 Phase

Nominal Performance

Capacity	480 / 498 Watts
	1,638 / 1,699 BTU/Hr
	413 / 428 Kcal/Hr
Power Input	356 / 370 Watts
Locked Rotor Amps	10.70 / 10.70 Amps
Max Continuous Current	- / - Amps
Rated Load Amps	1.75 / 1.78 Amps
COP	1.35 / 1.35 Watts / Watts
EER	4.60 / 4.59 BTU/W-Hr

Testing Conditions

Condensing Temperature	54.40 °C	129.9 °F
Evaporating Temperature	-23.30 / - °C	-9.9 / - °F
Liquid Temperature	32.20 °C	90.0 °F
Return Gas Temperature	32.20 °C	90.0 °F
Ambient Temperature	32.20 °C	90.0 °F

Application

Evaporating Temp. Range	LBP	@ -40.00 ° C to -12.20 ° C (-40.0° F to 10.0° F)
	Heat Pump	- ° C to - ° C (-° F to -° F)
Refrigerant	R404A/R507	
Refrigerant Flow Control	Capillary Tube	
Compressor Cooling	Fan	

Compressor and Motor data

Compressor Type	Reciprocating
Displacement	12.05 cc.
Oil Type	Polyolester Oil
Oil Charge	307 cc.
Motor Type	C.S.R. ; 2 Pole 2,850 / 2,850 r/m
Voltage Range	187-264/- Volts 50/- Hz.
Winding Resistance at 25 ° C	
Start	17.70 Ohms
Run	6.10 Ohms
Weight with Oil	11.80 Kg.
Weight with Oil and Accessories	12.25 Kg.

Electrical Components

Motor Protector	
Type	External 3/4"
Model Number	KME660-21/C
Open / Close	100-110 / 78-60 ° C
1st Cycle trip at 25 ° C	8.00 Amps(main) - Amps(start)
Motor Starter	
Type	Current Relay
Model Number	KME682-1NT
Pick Up (max.)	6.70 Amps
Drop Out (min.)	5.90 Amps
Terminal Cover	KMD 901-12
Start Capacitor	36-43 µF 330 VAC.
Disch Resistor for Start Cap	15000 Ohms 2 W
Run Capacitor	8 µF 450 VAC.

Mounting Kit

Rubber Grommet	4007KMD905-3
Sleeve Grommet	3KMD903-2-Z
Washer	4023KEB387

Since we are constantly improving our product , the specification are subject to change without notice.

REV. DATE	C / N No.
01-06-16	0189/16

Certificate Marks

www.alamko.by

